

Specifications

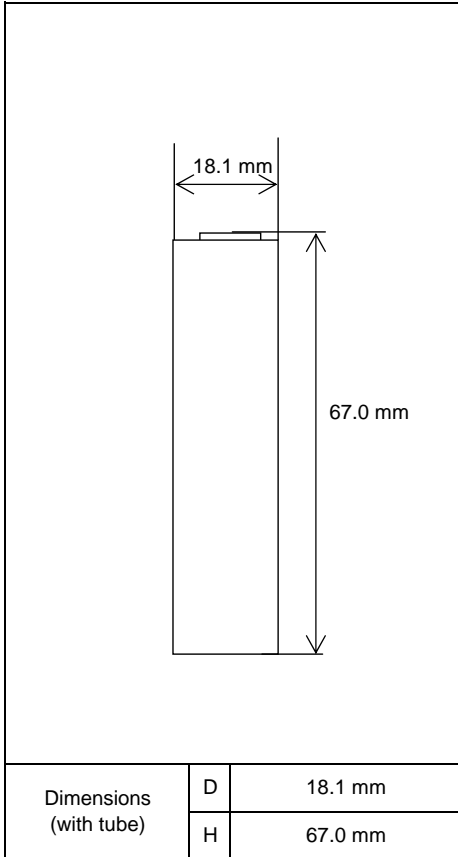

Type : Nickel-Metal Hydride Battery		Size : 4/3FA	
Capacity ¹⁾	Typical	4000mAh	
	Minimum	3750mAh	
Nominal Voltage		1.2V	
Charging Current x Time	Fast Charge ²⁾	4000 mA x about 1.1h	
Ambient Temp.	Charge Condition	Fast Charge ²⁾	
	Discharge Condition		
	Storage Condition	Less than 30days	0°C - 50°C
		Less than 90days	-20°C - 50°C
Less than 1year		-20°C - 40°C	
Internal Impedance ³⁾ (after discharge to E.V.=1.0V)		Approx. 7mΩ(at 1000Hz)	
Weight ⁴⁾		Approx. 60 g	
Size ⁴⁾ : (Diameter) x (Height)		18.1(D) x 67.0(H) mm	

- 1) Single cell capacity under the following condition.
 Charge : 400mA x 16h, Discharge : 800mA (E.V.=1.0V) at 20°C
 2) Use recommended charging system.
 3) After a few charge and discharge cycles under the above 1) condition.
 4) With tube.

Typical Characteristics

Charge

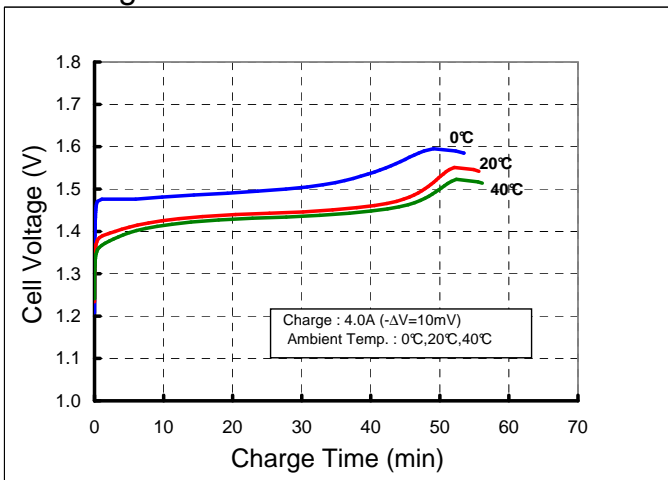

Discharge

