

LC-R0612P/P1*1

FOR MAIN AND STANDBY POWER SUPPLIES.
 EXPECTED TRICKLE DESIGN LIFE: 6 - 9 YEARS AT 20°C
 ACCORDING TO EUROBAT.

DIMENSIONS (MM)

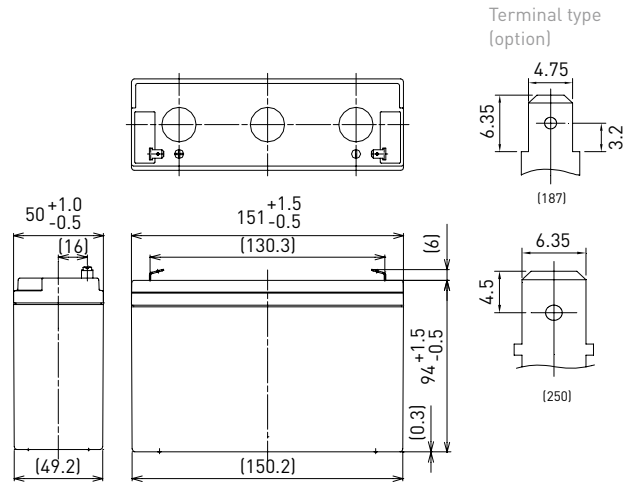

Contents indicated (including the recycle marking, etc.) are subject to change without notice. Battery case resin: standard (UL94 HB)

Specifications		LC-R0612P/P1*
Nominal voltage (V)		6
Nominal capacity	20 hours rate (Ah)	12.0
Dimensions	Length (mm)	50
	Width (mm)	151
	Total height (mm)	100
Approx. mass (kg)		1.95
Terminal type		Faston 187/250
Capacity (25°C)	20 hours rate (Ah)	12.0
	10 hours rate (Ah)	6.6
	3 hours rate (Ah)	5.8
	1 hour rate (Ah)	4.9
Impedance (mΩ)	Fully charged battery (25°C)	11
	Temperature dependency of capacity (%) - 20 hours rate	
	40°C	102
	25°C	100
	0°C	85
	-15°C	65
Remaining capacity (25°C)	After 3 months (%)	91
	After 6 months (%)	82
	After 12 months (%)	64

DURATION OF DISCHARGE VS. DISCHARGE CURRENT

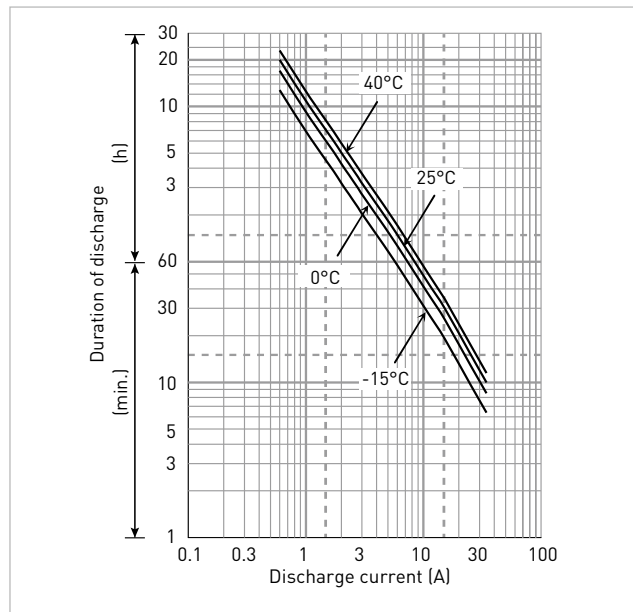

WATT TABLE (25°C)

(Wattage/battery)

Cut-off	3min.	5min.	10min.	15min.	20min.	30min.	45min.	1h	1.5h	2h	3h	4h	5h	6h	10h	20h
4.80V	340	279	192	149	124	91.3	68.7	52.4	35.1	27.2	19.0	14.4	12.0	10.9	6.66	3.61
4.95V	325	269	186	144	121	88.3	67.5	51.8	35.0	27.1	18.9	14.4	12.0	10.9	6.66	3.61
5.10V	304	253	181	141	118	87.2	66.9	51.2	34.5	26.9	18.7	14.4	12.0	10.8	6.60	3.61
5.25V	278	237	171	136	115	86.0	66.3	50.1	34.2	26.6	18.4	14.3	12.0	10.8	6.60	3.60
5.40V	247	217	161	131	113	83.1	61.6	48.9	33.1	26.0	18.1	14.2	11.9	10.7	6.54	3.59

AMPERE TABLE (25°C)

(Ampere/battery)

Cut-off	3min.	5min.	10min.	15min.	20min.	30min.	45min.	1h	1.5h	2h	3h	4h	5h	6h	10h	20h
4.80V	61.1	50.1	34.3	25.9	21.3	15.6	11.7	8.90	5.95	4.60	3.20	2.41	2.01	1.81	1.11	0.602
4.95V	58.4	48.2	33.3	25.0	20.8	15.1	11.5	8.80	5.92	4.58	3.18	2.41	2.01	1.81	1.11	0.602
5.10V	54.6	45.4	32.4	24.5	20.3	14.9	11.4	8.70	5.85	4.55	3.15	2.41	2.00	1.80	1.10	0.601
5.25V	50.0	42.6	30.6	23.6	19.9	14.7	11.3	8.50	5.80	4.50	3.10	2.40	2.00	1.80	1.10	0.600
5.40V	44.5	38.9	28.7	22.7	19.4	14.2	10.5	8.30	5.60	4.40	3.05	2.38	1.99	1.79	1.09	0.598

All mentioned values are average values

*1 This battery is also available with a flame-retardant battery case resin (UL94 V-0): LC-V0612P/P1.

LC-R0612P/P1*1

CHARGING METHOD (25°C)

Cycle use	Control voltage: 7.25V - 7.45V Initial current: 4.80A or smaller
------------------	---

CUT-OFF VOLTAGE

Discharge current	0.600A - 2.40A	2.40A - 6.00A	6.00A - 12.0A	12.0A - 24.0A	24.0A - 36.0A
Cut-off voltage	5.25V	5.10V	4.95V	4.65V	4.35V

CYCLE LIFE VS. DEPTH OF DISCHARGE (ACC. IEC 61056)

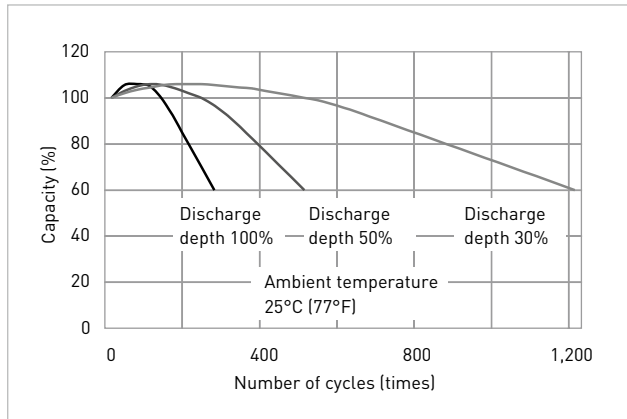

RESIDUAL CAPACITY TEST RESULT

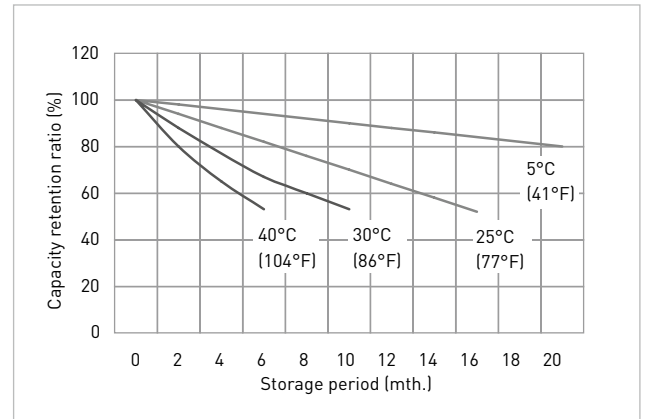

CONSTANT-VOLTAGE CONSTANT-CURRENT CHARGE CHARACTERISTICS FOR CYCLE USE

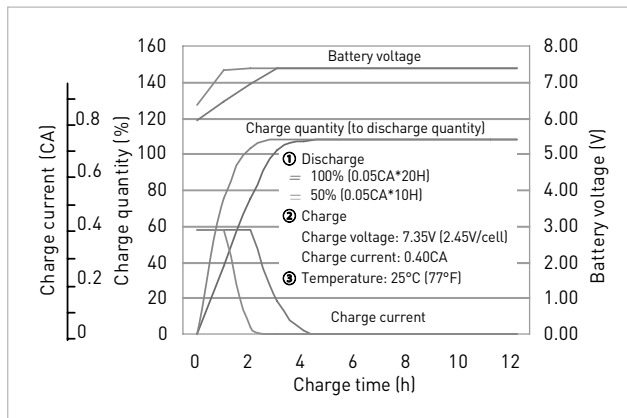

DISCHARGE CAPACITY BY TEMPERATURE AND BY DISCHARGE CURRENT

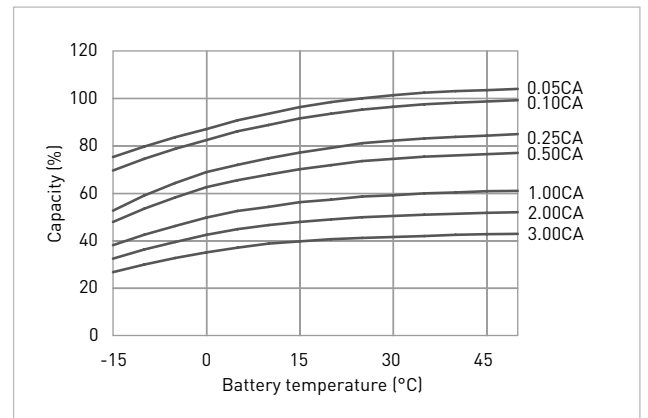

DISCHARGE CHARACTERISTICS

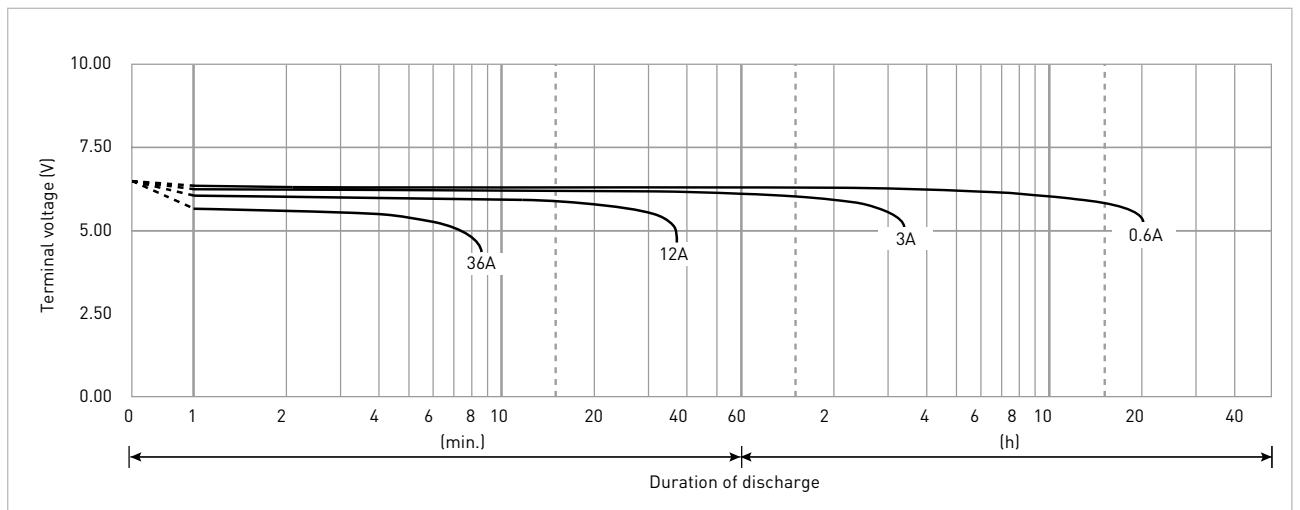

*1 This battery is also available with a flame-retardant battery case resin (UL94 V-0): LC-V0612P/P1.